

USER GUIDE

PS300

PORTABLE POWER STATION



CONTENTS

1.	Product Overview	3
2.	Button Functions	4
3.	LCD Features	6
4.	Fault Resolution	7
5.	AC 240V/Wall Plug Charging	7
6.	Solar Panel Charging	7
7.	Car/Vehicle Charging	8
8.	General Specifications	9
9.	Battery Specifications	9
10.	Safety Precautions	10
11.	Contact Us	Back page

PRODUCT OVERVIEW

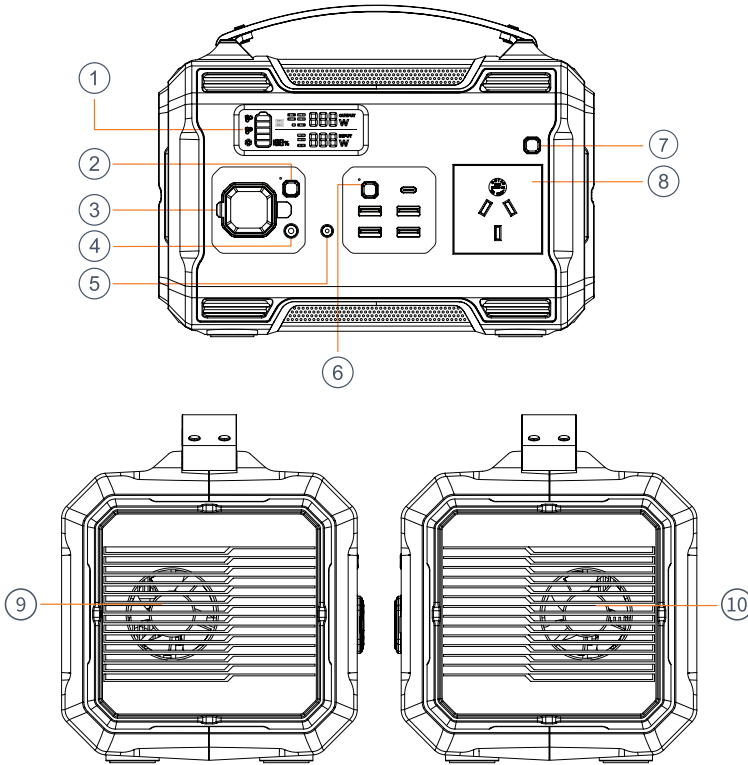

Accessory List

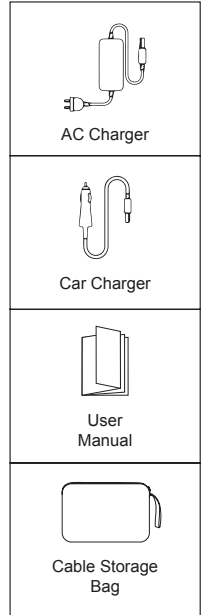

- ① LCD DISPLAY
- ② DC CONTROL
- ③ CIGARETTE LIGHTER OUTPUT
- ④ DC OUTPUT PORT
- ⑤ DC INPUT PORT
- ⑥ DC CONTROL
- ⑦ AC 240V OUTPUT BUTTON
- ⑧ AC 240V OUTPUT PORT
- ⑨ AIR OUTLET
- ⑩ AIR INTAKE



BUTTON FUNCTIONS

POWER CONTROL:

A short press of the AC, USB, or DC output button to turn the unit on and a long press of the DC and USB output buttons together to turn the unit off. When not in use, please turn the unit off.



USB CONTROL BUTTON:

Make sure the power station is on before pressing the USB control button. Operation: short press to turn on/off.

 USB x 2	 USB x 2	 USB-C x 1
QC 3.0	5V/2.4A	100W

DC CONTROL BUTTON:

Make sure the power button is on before pressing the DC control button. Operation: short press to turn on/off.

 DC Output x 1	 Cig output x 1
12V/8A	12V/10A

LCD SCREEN DISPLAY:

Informative LCD display presents the remaining power and use data. The LCD display will enter sleep mode after 30 seconds of inactivity and wake up when inputting charge or when any button is pressed. The device will remain active and won't enter sleep mode if it is either charging or discharging.

AIR INTAKE/OUTLET (BUILT-IN COOLING FAN):

The PS300 utilises an internal cooling fan to ensure it operates within the appropriate temperature range. When the PS300 experiences a high output/input

load, it automatically turns on the fan. The fan may turn on intermittently to keep the temperatures within the operating range. Please ensure you do not block or cover the channel.

WARNING:

Maintain a space of 30cm away from the side suction and exhaust ports to ensure proper heat dissipation.

AC 240V OUTPUT BUTTON:

To activate the AC output function, simply press the AC button. Keep in mind that AC output frequency and voltage may vary depending on your location. If you need to adjust these settings, follow these steps:

1. Press and hold the AC button for 3 seconds to enter the frequency switching mode. You'll notice that the 50Hz or 60Hz icon will start flashing on the display.
2. Give the AC button a short press again to select between 50Hz or 60Hz. Wait until the flashing icon stops and displays your chosen frequency (either 50Hz or 60Hz), which indicates a successful switch.
3. To adjust the voltage, quickly press the AC button 10 times. This will allow you to cycle through available voltage options.

By following these steps, you can easily customise the AC output frequency and voltage to suit your specific needs.

DC PORT (SOLAR/CAR INPUT):

To charge the power station with a solar panel, you are required to have a DC5521 compatible connection, the maximum input of the solar panels is 80W and the maximum voltage is 30V (do not exceed 30V).

AC INPUT:

Use the included wall socket to get 60W fast charging, which can fully charge the PS300 from 0 to 100% in 5 hours.

To charge your PS300 in 2 hours, simultaneously connect the 100W USB-C while the unit has 60W AC input.

OVERLOAD PROTECTION:

To safeguard the power station from potential damage resulting from excessive AC input current due to lightning or grid fluctuations, the overload protector is designed to activate and disconnect the AC input in such situations.

If the overload protector has been triggered, and you need to restore the AC input, please follow these instructions:

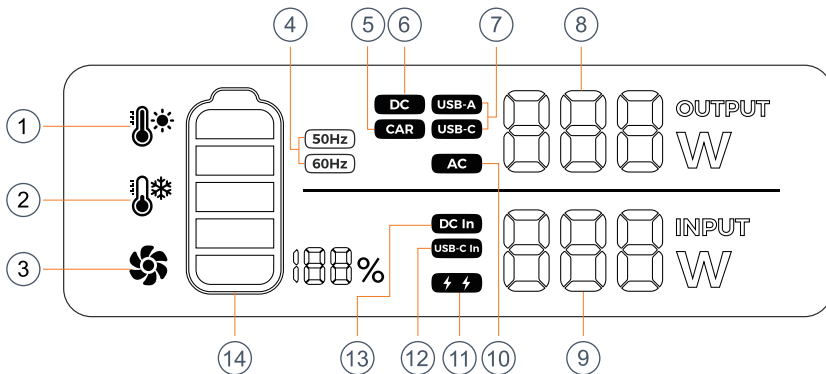

1. First, ensure that the PS300 is turned off, and unplug all connected devices and ports from it.
2. Confirm that all connected ports are in their standard, normal state.
3. Now, you can turn on the PS300.

LCD FEATURES:

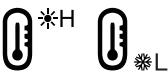

- | | |
|-----------------------------|------------------------|
| ① HIGH TEMPERATURE | ⑧ TOTAL OUTPUT POWER |
| ② LOW TEMPERATURE | ⑨ TOTAL INPUT POWER |
| ③ FAN STATUS | ⑩ AC OUTPUT STATUS |
| ④ OUTPUT FREQUENCY | ⑪ CHARGING STATUS |
| ⑤ CIG LIGHTER OUTPUT STATUS | ⑫ USB-C INPUT STATUS |
| ⑥ DC OUTPUT STATUS | ⑬ DC INPUT STATUS |
| ⑦ USB OUTPUT STATUS | ⑭ BATTERY PROGRESS BAR |

FAULT RESOLUTION

Status	Explanation	Resolution
 <p>Above icon flashes and buzzes</p>	<p>The output exceeds the standard and it's short-circuited.</p>	<p>1 - First, ensure that the PS300 is turned off, and unplug all connected devices and ports from it.</p> <p>2 - Confirm that all connected ports are in their standard, normal state.</p> <p>3 - Now, you can turn on the PS300.</p>
 <p>The temperature warning icon flashes and buzzes</p>	<p>This product has surpassed the recommended temperature limit.</p>	<p>Remove all loads, disconnect the power source from this product, and wait for the unit to cool down to an appropriate temperature before proceeding (between -10°C~40°C).</p>
 <p>Charging unavailable</p>	<p>Bad wire connection.</p>	<p>Verify the connection status of the power line and the power supply to ensure they are properly connected.</p>

AC CHARGER CHARGING

Use the AC charger provided to charge this unit. It will only require 5 hours to fully charge the PS300.

SOLAR PANEL CHARGING:

1. Do not charge the PS300 via a solar panel that has a voltage exceeding 30V.
2. Supports 80W max solar input (solar panels not included), the charging time depends on the solar panel input.
3. To ensure proper operation, please verify that there is no regulator in the line. You will need to input unregulated solar power into the PS300 as it already contains a built-in regulator.

Connecting Pattern 1

THE AREA OF CHARGING

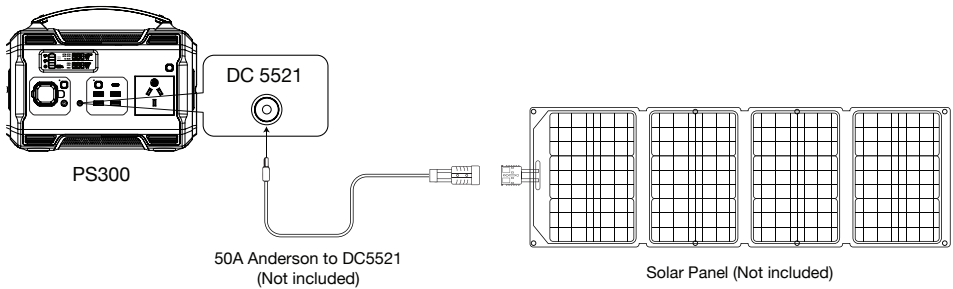

CAR/VEHICLE CHARGING

It's important to use the car charger that was provided with the unit for charging. Car chargers usually provide lower power outputs, typically around 90-120 watts. As a result, charging times may be extended. If you require a quicker charge, it is recommended to use the AC adapter that came with the device in combination with a USB-C cable. This will provide a 160W charge rate which is better suited for fast charging.

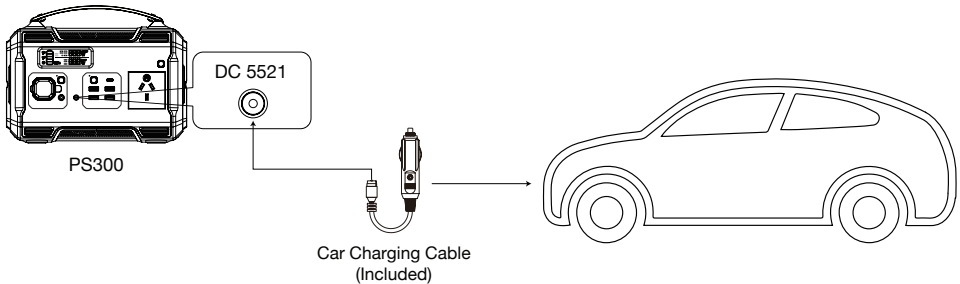

GENERAL SPECIFICATIONS

Model name	PS300
Dimensions	248*164*169mm
Weight	3.4Kg
DC5521 input	13V-30V 80W Max
AC output	50/60Hz (frequency switch available), rated at 300W Pure Sine Wave. Built in overload and short circuit protection.
USB output	2 x 5V/2.4A
USB QC3.0 output	2 x 18W
USB-C input/output	100W
DC 5521 output	12V/8A
Cigarette lighter output	12V/10A
Power off current	<800uA
Operating temperature	-10~40°C
Environment humidity	≤90%RH
Cycle life	>3500 times

BATTERY SPECIFICATIONS

Battery type	LiFePO4
Single cell rated voltage	3.6V
Single cell rated capacity	3200mAH
Battery pack rated voltage	10.8V
Battery pack output voltage	9.0-12.6V
Battery pack rated capacity	276WH

SAFETY PRECAUTIONS

For safe operation and optimal performance, the PS300 Portable Power Station must be operated correctly. Please carefully read, understand, and follow all instructions and guidelines in this user guide. Failure to follow these instructions may result in damage to the unit, property, death, or serious injury.

Disclaimer: While iTechworld has taken every precaution to ensure the accuracy of the contents of this user guide, iTechworld assumes no responsibility for any errors or omissions.

Furthermore, all specifications and functionality may change at any time without notice.

It is best to view our website for the most up-to date information.

WARNING:

People with physical disabilities, visual, sensory, or mental impairments (including children) should not use this device. Children should be supervised to ensure they do not play with the power station.

DANGER:

Do not disassemble or modify the power station; doing so will result in your warranty being void, it may result in a risk of electrical shock, fire, death, or serious injury.

EXPLOSION HAZARD:

Do not use the power station in an environment where flammable fumes or gases are present (such as gas bottles, petrol engines, or lead-acid battery compartments).

WARNING:

Avoid using the power station in extreme temperatures, high humidity, direct sunlight, and near fire.

WARNING:

Please use the wires recommended in this user guide; otherwise, it may result in damage to the power station, a risk of electrical shock, fire, death, or serious injury.

WARNING:

Do not drop the power station.

WARNING:

When not using the power station, turn off the power and unplug the power cord.

WARNING:

Do not use the power station and its accessories to connect equipment if there is a defect.

DANGER:

Never smoke or allow a spark or flame in the vicinity of the power station. This may cause the battery to explode.

LIMITATIONS OF USE:

Do not use in connection with life support systems or other medical equipment or devices.

LONG TERM STORAGE:

For long-term storage, discharge the power from full to empty once every three months, and then recharge it to 75%. Ensure the power is turned off completely.

iTECHWORLD

THE POWER EXPERT

CONTACT US



1300 483 249



service@itechworld.com.au



www.itechworld.com.au

When it comes to energy storage and creation at iTechworld, we take pride in being one of the biggest names in the industry. Based in Australia, we are a family-owned and operated business. With many more innovative products on the horizon we are committed to constantly raising the bar to provide bigger and better benefits to all our customers Australia-wide.

Whether you're an avid camper, 4WD enthusiast, freedom seeker or camper, we've got your power needs covered. Escape the grid without compromise, minimise your downtime and travel with comfort with our large range of leading products at great prices.

iTechworld. The Power Expert.

LOVE YOUR PS300? **LEAVE A REVIEW**



Google
Reviews ★★★★★



PRODUCT
REVIEW
.COM.AU